

J1 - 115 X 205 CM (X4)
ESC: 1/25

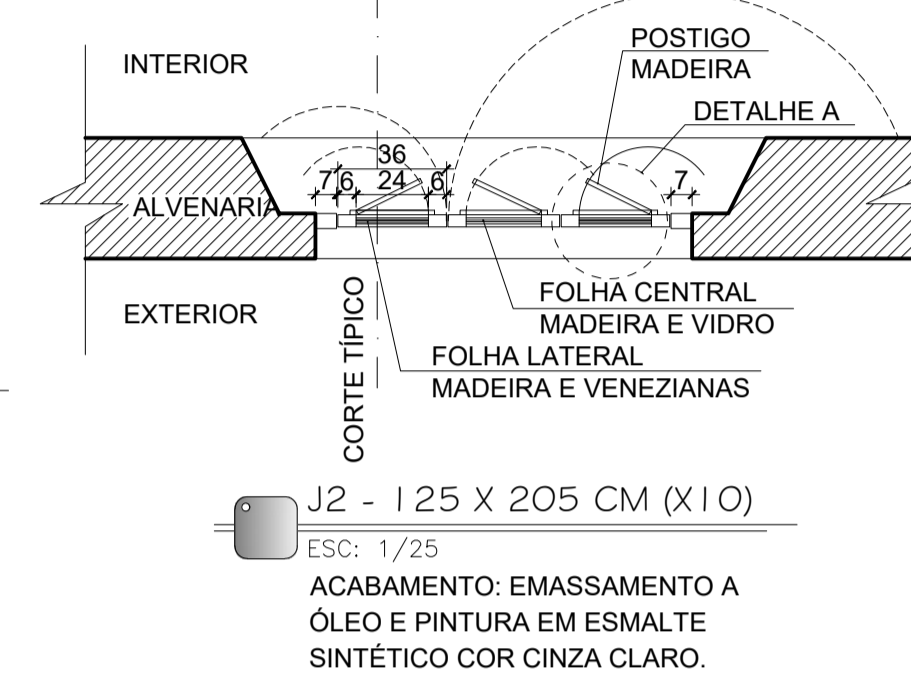

P4 - 90 X 210 CM (X2)
ESC: 1/25



J2 - 125 X 205 CM (X10)
ESC: 1/25
ACABAMENTO: EMASSAMENTO A ÓLEO E PINTURA EM ESMALTE SINTÉTICO COR CINZA CLARO.

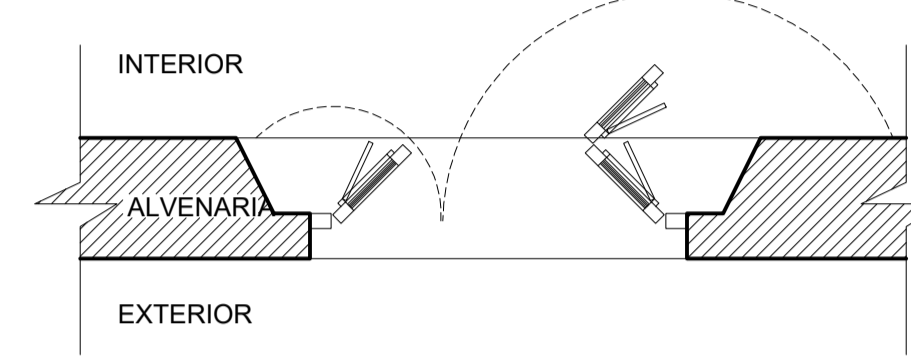

ALMOFADAS
MARCO E ALIZARES EM MADEIRA MACIÇA DE LEI



P5 - 80 X 210 CM (X10)
ESC: 1/25
ACABAMENTO: EMASSAMENTO A ÓLEO E PINTURA EM ESMALTE SINTÉTICO COR CINZA CLARO.

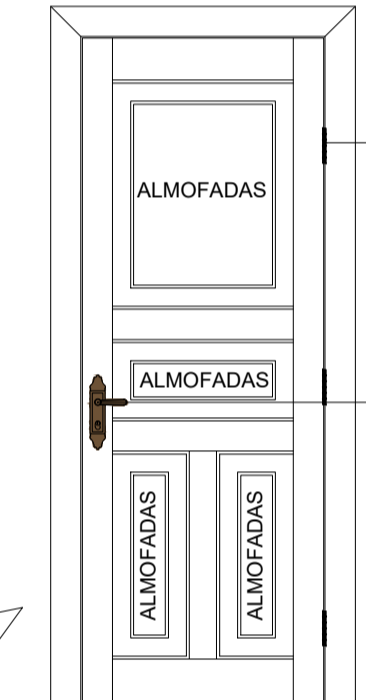

NOTA: FORNECER E INSTALAR TODAS AS DOBRADIÇAS, TRINCOS E FERRAGENS DE PORTA

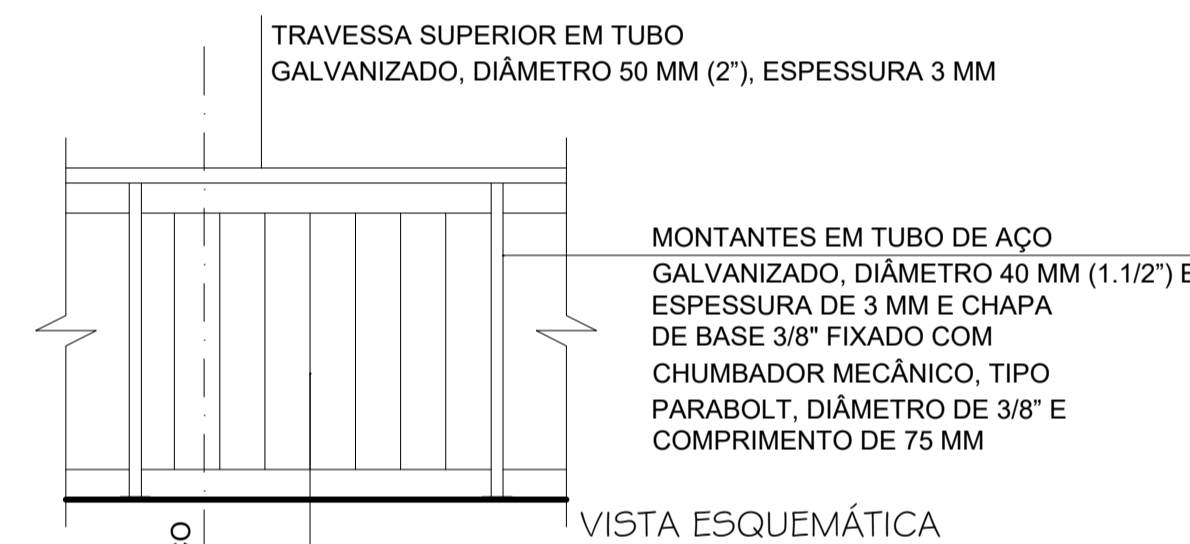
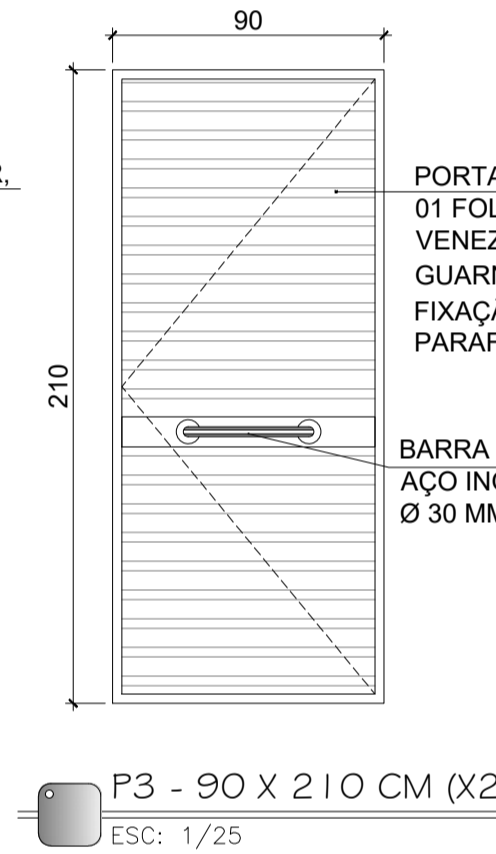
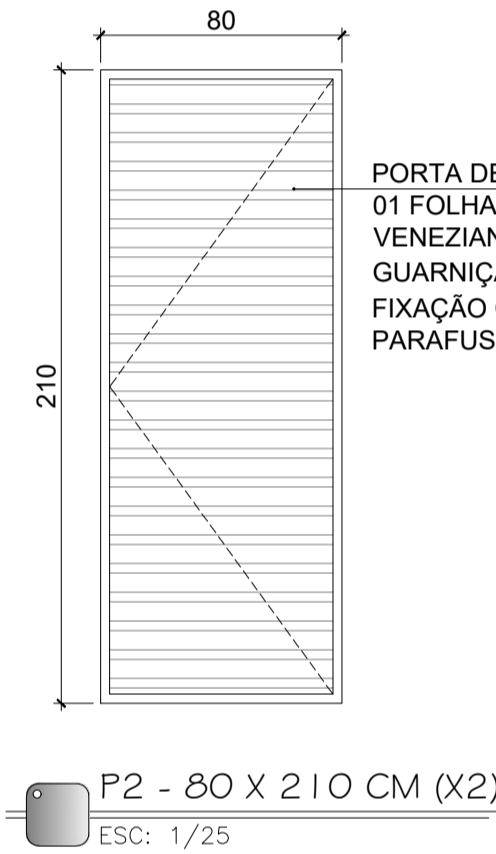
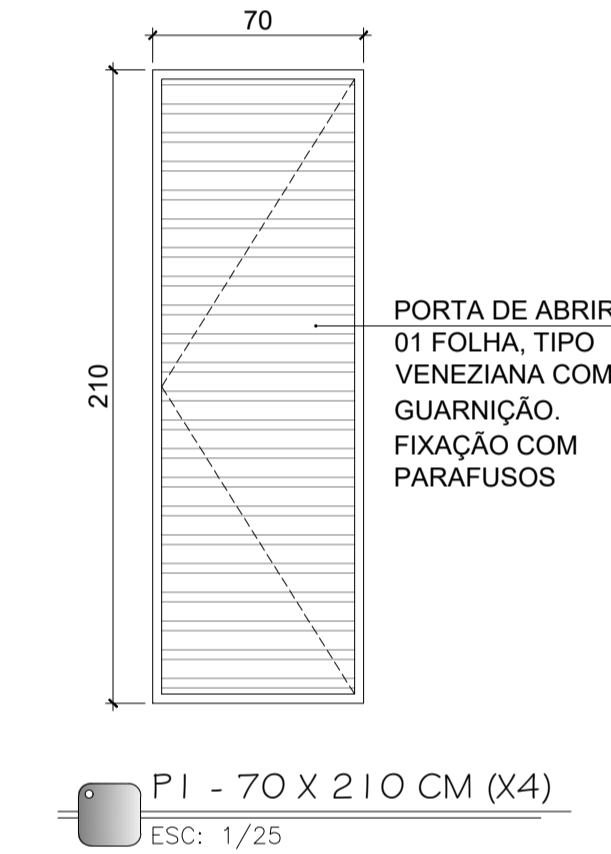

GRADIL FORMADO POR BARRA CHATA, AÇO ASTM A 36, DIMENSÕES 1.1/2" X 3/16" (32 X 4,8 MM)

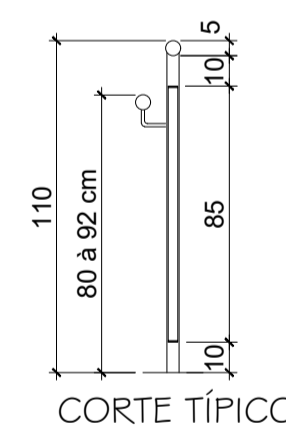

GUARDA-CORPO E CORRIMÃO
ESC: 1/25
ACABAMENTO: PINTURA EM ESMALTE SINTÉTICO COR BRANCO

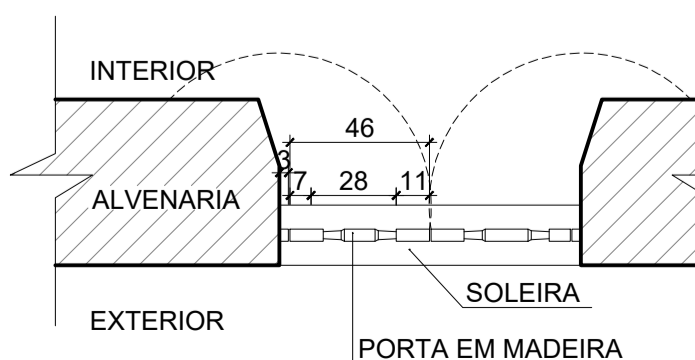
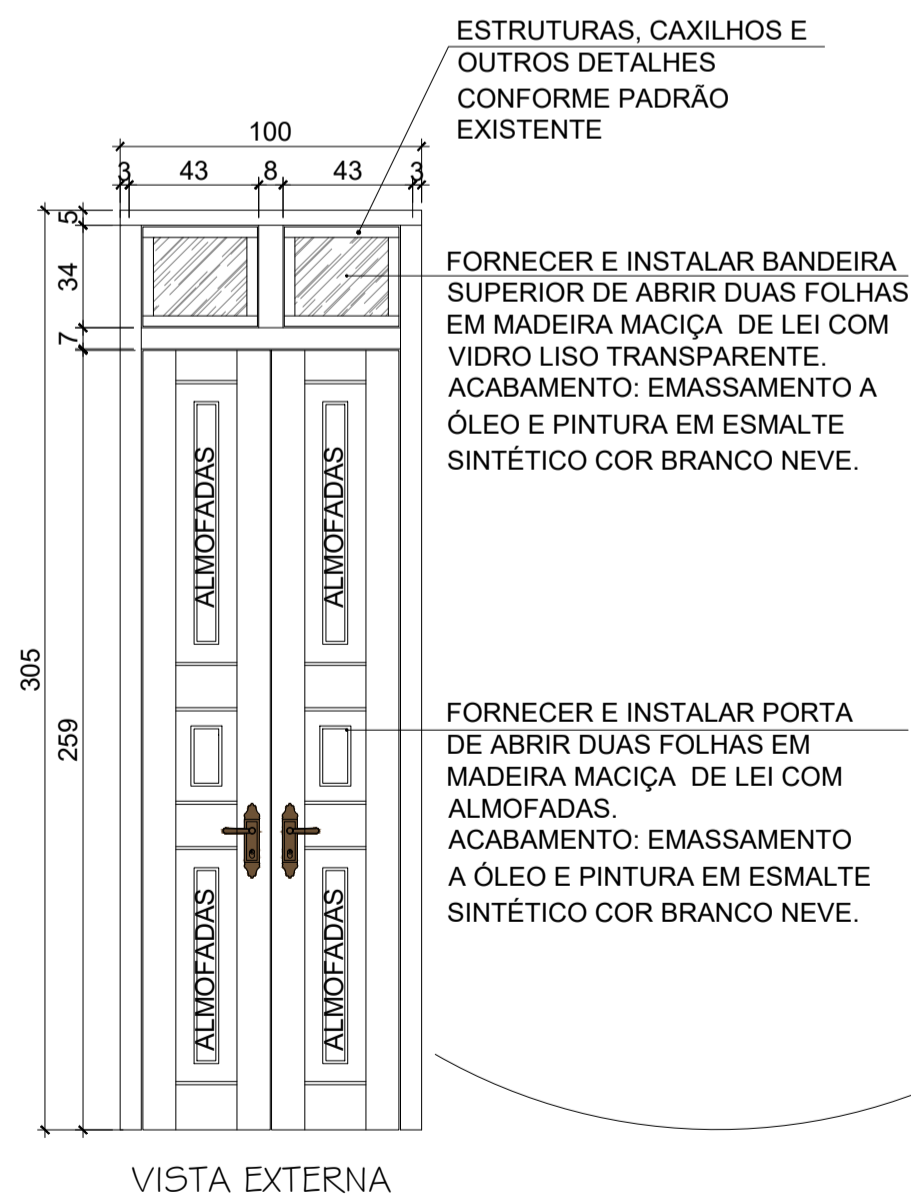

P6 - 100 X 305 CM (X1)
ESC: 1/25
ACABAMENTO: EMASSAMENTO A ÓLEO E PINTURA EM ESMALTE SINTÉTICO COR CINZA CLARO.

QUADRO DE ESQUADRIAS								
COD	TIPO	LARG. (CM)	ALT. (CM)	PARAPEITO (CM)	MATERIAL	Área (m²)	QTD.	LOCALIZAÇÃO
B1	MAXIM-AR 1 FOLHA	80	40	170	ALUMÍNIO E VIDRO	0,32	6	WC FEM./ WC MASC./ WC PNE
B2	MAXIM-AR 1 FOLHA	120	40	170	ALUMÍNIO E VIDRO	0,48	2	COPA/ ALMOXARIFADO
J1	JANELA DE ENROLAR + GRADIL + VIDRO	115	165	100	FERRO E VIDRO	1,90	4	GALERIA DE ARTES
J2	JANELA PANTOGRÁFICA 3 FOLHAS	125	205	100	MADEIRA	2,56	10	SALAS PAVIMENTO SUPERIOR
P1	PORTA DE ABRIR	70	210	-	VENEZIANA DE ALUMÍNIO	1,47	4	WC FEM./ WC MASC.
P2	PORTA DE ABRIR	80	210	-	VENEZIANA DE ALUMÍNIO	1,68	2	COPA/ ALMOXARIFADO
P3	PORTA DE ABRIR	90	210	-	VENEZIANA DE ALUMÍNIO	1,89	2	WC PNE
P4	PORTA DE ABRIR	90	210	-	AÇO COM VIDRO	1,89	2	PLATAFORMA ACESSIBILIDADE
P5	PORTA DE ABRIR	80	210	-	MADEIRA	1,68	10	SALAS PAVIMENTO SUPERIOR
P6	PORTA DE ABRIR 2 FOLHAS	100	305	-	MADEIRA	3,05	1	CIRCULAÇÃO/ FACHADA FUNDOS
P7	PORTA PANTOGRÁFICA 4 FOLHAS	140	305	-	MADEIRA	4,27	3	FACHADA FRONTAL_PAVIMENTO SUPERIOR
P8	PORTA DE ABRIR 2 FOLHAS	170	300	-	MADEIRA	5,10	1	HALL ESCADA_TÉRREO
P9	PORTA DE ENROLAR + GRADIL + VIDRO	140	300	-	CHAPA RAIADA + GRADIL + VIDRO TEMPERADO	4,20	1	GALERIA DE ARTES
P10	PORTA DE ENROLAR + GRADIL + VIDRO	170	300	-	CHAPA RAIADA + GRADIL + VIDRO TEMPERADO	5,10	2	GALERIA DE ARTES
P11	PORTA DE ENROLAR + GRADIL + VIDRO	200	300	-	CHAPA RAIADA + GRADIL + VIDRO TEMPERADO	6,00	1	GALERIA DE ARTES
P12	PORTA DE ABRIR	50	180	-	VENEZIANA DE ALUMÍNIO	0,90	2	SHAFT

TÍTULO:
Projeto de Restauração do Casarão Madame Albertina Holz, localizada na Av. Rio Doce, nº 34, Centro - Baixo Guandu/ ES

PREFEITURA DE BAIXO GUANDU

PROPRIETÁRIO: Município de Baixo Guandu
CNPJ: 27.165.737/0001-10

RESP. TÉCNICO: Fabrício Benício de Brito
Engenheiro Civil - CREA: ES-014512/D

DESENHO: Priscila David da Silva
Engenheira Civil - CREA: ES-040521/D

BETELHES: Esquadrias

ASSUNTO: Arquitetura
FOLHA: 01/03
DATA: FEV/ 2022